

W5

Custom-built wheelchair for active use

Order Form



49 Bespoke Inc.
 137 Buttermill Avenue
 Concord, ON L4K 3X5, Canada
 Telephone: +1.416.661.4499
 Fax: +1.416.661.8903
 E-Mail: 49@49bespoke.com
 www.49bespoke.com

Fill in and send to 49 Bespoke Inc.

Subject to Technical Modifications and Printing Errors

W5 EN-DA 2016 v5.4

User Information	
User Name	
Address	
Phone	
E-mail	
Weight	_____ kg
Height	_____ cm
<input type="checkbox"/> Offer Only	<input type="checkbox"/> Order
Payment Details	
EAN number	
Your PO Number	
Invoice Recipient	
Phone	
E-mail	
Contact	
Name and Address	
Phone	
E-mail	
Shipping Information	
<input type="checkbox"/>	Consultant
<input type="checkbox"/>	User
<input type="checkbox"/>	Other address
Optional Notes	
Consultant	Date



Default Equipment

- Tailor-made rigid-frame wheelchair
- Fully welded or adjustable versions available
- Made of 7020 T6 aluminum
- Adjustable seat and back upholstery
- Impact-resistant anodised frame
- Drive wheels with quick-release axles

Tailor-made Wheelchair

Remarks

REMARKS

- this combination/option is available
- this combination/option is **non-available**
- ! this information is mandatory and must always be filled in

**For options or solutions not mentioned in this order form, please, contact 49 Bespoke Inc.
See contact information at the starting of the page.**

DECAL(S): The user's name or other message(s) printed on the frame

! Model (mandatory)

W5	<input type="checkbox"/>	Original
W5 S	<input type="checkbox"/>	Streamlined lower frame
W5 K	<input type="checkbox"/>	Short frame, the footrest is between casters
W5 D	<input type="checkbox"/>	Double footrests



! Colour (mandatory) / Farve (skal udfyldes)

6190 0000 1009	<input type="checkbox"/>	Black anodized	6190 0000 2309	<input type="checkbox"/>	Golden brown
6190 0000 1109	<input type="checkbox"/>	Silver anodized	6190 0000 2409	<input type="checkbox"/>	Red
6190 0000 1209	<input type="checkbox"/>	Blue anodized	6190 0000 2509	<input type="checkbox"/>	Shiny black
6190 0000 1309	<input type="checkbox"/>	Red anodized	6190 0000 2609	<input type="checkbox"/>	Orange
6190 0000 2109	<input type="checkbox"/>	White	6190 0000 2709	<input type="checkbox"/>	Blue
6190 0000 2209	<input type="checkbox"/>	Green	6190 0000 2809	<input type="checkbox"/>	Matt black
6190 0000 3009	<input type="checkbox"/>	Customized color	! Color code		

Custom-built from Drawings/notes (go to page 14)

	<input type="checkbox"/>	Custom ideas and/or solutions from individually designed drawings
--	--------------------------	---

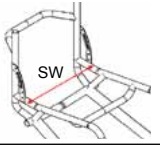
! Frame Data (mandatory)/Rammedata (skal udfyldes)

1110 ???? FF09	[!]	SW: Seat width - outer measurement (std. 36, 38, 40, 42, 45, 48 cm)			_____ cm	
1110 ???? FF09	[!]	FD: Frame depth (default 44 cm) (see note (2) below)	_____ cm	SD-min (2) = Shortest seatd. (std. 39 cm)	_____ cm	

(2) Seat adjustability: You must fill in the SD minimum and define the minimum seat depth required.

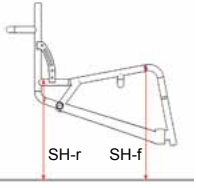
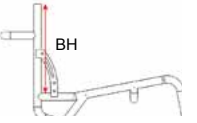
6160 00?? 0009	[!]	SH-r: Seat height from the rear edge seat to the floor (default 42 cm)		[!]	_____ cm	
6150 00?? 0009	[!]	SH-f: Seat height from the front of the seat to the floor (default 48 cm)			_____ cm	
6115 00?? 0009	[!]	C: Camber angle rear axle 1°-3°-5° (default 3°)			_____ °	
81?? ???? FF09	[]	BH: Fixed back height	_____ cm	BH: Adjustable back height (default 35-41 cm)		
	[]	BH: Back height (see note (1))		Fill in the BH-max and H-min	BH-max: _____ cm BH-min: _____ cm	

(1) For adjustable back height: Fill in the BH-max with the necessary max. back height (max 6 cm more than BH, straight back tubes only)

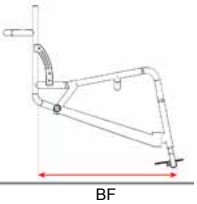
	[!]	BF: From the front of backrest to the front of footrest (default 60 cm)		_____ cm	
These 3 measures are normally optimized during the production process	[]	BC: From the front of the backrest to the center of the casters (default 50 cm)		_____ cm	
	[]	TW: Total width including wheels (minimum SW + 17cm, C=1°)		_____ cm	
	[]	CW: Distance between the casters (center to center) CWmin = FF+15 cm / 100 mm wheel		_____ cm	

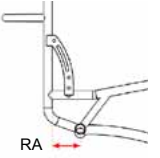

! Rear Axle (mandatory)

6110 0000 0001	[]	Adjustable axle	[!]	RA: (default 8 cm)	_____ cm	
6110 00?? 0009	[]	Fixed axle, welded	[!]	RA: (standard 8 cm)	_____ cm	
Rear axle system	[]	½" Quick-release (default / Standard)	[]	Wrex 25 mm, 0-tolerance axle, Wrex wheel only (p. 13)		
6910 0001 0100	[]	Extra rear axle for use with hand bike	[!]	HRA:	_____ cm	
Rear wheel size	[!]	_____ (std. 24")	Front wheel size	_____ " (std. 4")		Selection page 12-13

Wheel-locks, Low Fixation

6910 0002 0001	[]	Extra tubes welded on the frame to be used for wheel-locks
----------------	-----	--

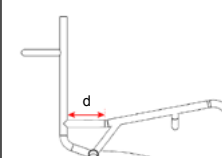

Sideguard Attachment System (our recommended solution)			
6810 0001 0005	<input type="checkbox"/>	Fixed by welding (aluminum only)	For welded back only
6810 0001 0050	<input type="checkbox"/>	Fixed by screws on welded tabs	For fixed back only
6810 0001 0001	<input type="checkbox"/>	Lift-off sideguards (standard)	12 cm from back
	<input type="checkbox"/>	Fittings for lifting the detachable sideguards (SW + 2 cm between sideguards)	Spinegy: Narrow chair
6810 0001 0002	<input type="checkbox"/>	Fittings for fixed sideguards with space for the folding back (width + 2 cm)	12 cm from back
9510 3848 0160	<input type="checkbox"/>	Kit for enlarging the distance between the sideguards (+ 3 cm)	
8831 2410 1002	<input type="checkbox"/>	Mounting bracket on back rest for swing away armrest (choose armrest, page 11)	Armrest page 11!
6810 0001 0010	<input type="checkbox"/>	Foldable, the sideguard stores on top of seat (tap welded on back tubes)	

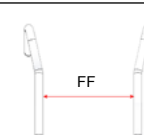
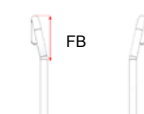
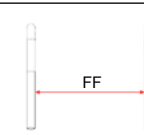
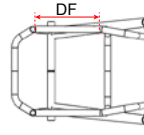
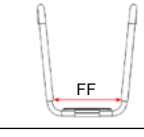
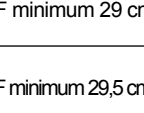

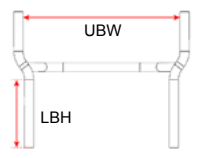
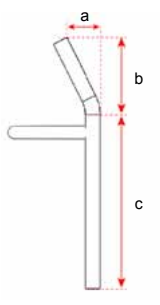
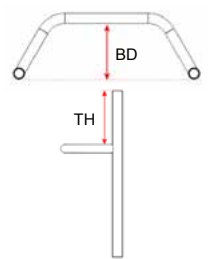
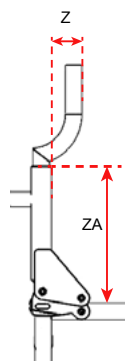
! Choice of Seat (mandatory)			
6100 00?? 0009	<input type="checkbox"/>	Ergonomically designed seat (default)	<input type="checkbox"/> d:(std 12 cm) 
6100 0000 0009	<input type="checkbox"/>	Straight seat tubes	

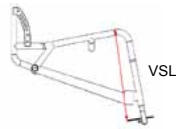
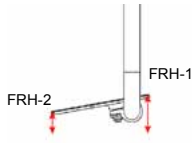
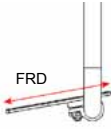
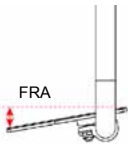
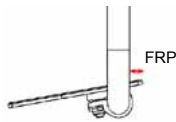
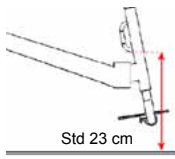

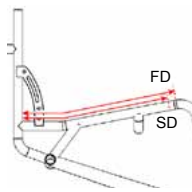

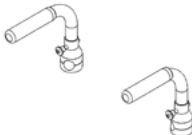
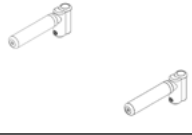

! Front Frame (mandatory)			
Standard is U-V and FF depends upon the SW (seat width) as follow:		SW/FF : 36/25,5 – 38/25,5 – 40/27,5 – 42/29,5 – 45/32,5 – 48/35,5 cm	
6120 00?? 0009	<input type="checkbox"/>	FF: U-V front frame	
	!	FB: Length to the front bend of the front frame (default 15 cm)	
6130 00?? 0009	<input type="checkbox"/>	FF: U front frame	
	!	DF: Length of seat tube before bend inwards for U front frame (std 30 cm)	
6140 00?? 0009	<input type="checkbox"/>	FF: V front frame, fixed welded footrest	
8299 9920 0001	<input type="checkbox"/>	DF: Double footplates, flip up (W5 D only)	 FF minimum 29 cm
8299 9903 0010	<input type="checkbox"/>	SF: Single flip-up (minimum and default size 29,5 cm)	FF minimum 29,5 cm

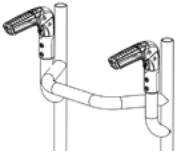
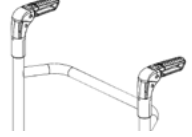
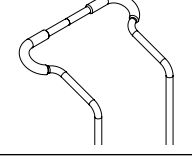
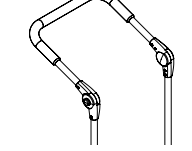
! Back System (mandatory)						
8111 ???? 1009	<input type="checkbox"/>	Folding back $\pm 4^\circ$ (default)	<input type="checkbox"/>	Folding back $+4^\circ$ to $+12^\circ$	 + Backwards - To the front	
8121 ???? 1009	<input type="checkbox"/>	Fixed back, welded	<input type="checkbox"/>	BA: Back angle _____ \pm cm		
8131 0000 1009	<input type="checkbox"/>	Light style folding back (Between sideguards: SW + 14 mm)				
8122 0020 0002	<input type="checkbox"/>	Narrow back	NB: The wide back is not available in combination with the folding back	UBW _____ cm	LBH _____ cm	
8122 0020 0001	<input type="checkbox"/>	Wide back		UBW _____ cm	LBH _____ cm	
	<input type="checkbox"/>	Bended on the back rest (1)	a: Backwards (+) <input type="checkbox"/>	a: Forwards (-) <input type="checkbox"/>	_____ cm	(1) When choosing bend on back, fill in a, b and c. 
	!	b: Length of the upper, bended part of the back tubes			_____ cm	
	!	c: Distance from the seat tube to the bend			_____ cm	
		Shape of the backrest tube	Standard <input type="checkbox"/>	Rounded <input type="checkbox"/>		
	!	BD: Depth of the backrest tube (BRT) depth (default 12 cm)			_____ cm	
	!	TH: The distance between the backrest and the top of the backrest's tubes (default 12 cm)			_____ cm	
8122 0020 01??	<input type="checkbox"/>	Wing back ILSA: Integrated multi-adjustable back support				
	<input type="checkbox"/>	Z: Firmspring 3 cm				
	<input type="checkbox"/>	Z: Firmspring 5 cm				
	<input type="checkbox"/>	Z: Firmspring 7 cm				
	<input type="checkbox"/>	Z: Custom depth _____ cm				
	!	ZA: Height from the seat to the start bend ILSA (default 19 cm)			_____ cm	
8122 0020 0060	<input type="checkbox"/>	Plate welded on the back for mounting of body support system				
6910 0001 0130	<input type="checkbox"/>	Bracket for locking the folded backrest				

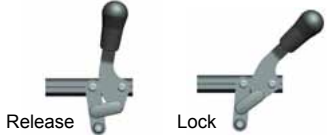
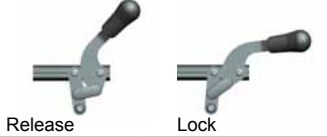
! Footrest (mandatory)					
6145 00?? 0001	[]	VSL: Front of the seat upholstery to the rear edge of the footrest std. 39 to 45 cm	_____ cm		
If both VSL and FRH is filled out, VSL will be leading.	[]	FRH: Height of the footrest (Alternative to VSL)	Front FRH-1: _____ cm	Rear FRH-2: _____ cm	
	[]	Footrest with an adjustable-by-angle footplate (default depth 12 cm)	[] FRD 12 cm [] FRD 16 cm FRD: _____ cm		
8219 ??00 ??00	[]	Footrest, open with two tubes			
8219 ???? ?09	[]	Footplate welded on footrest (Welded on tabs)			
8299 9901 0001	[]	Footplate welded on footrest (Welded on tabs)			
8299 9901 0005	[]	Footplate screwed on footrest w/ tabs			
8299 9901 0003	[]	Footplate that can be flipped up to the rear			
8299 9903 0010	[]	Otto Bock swing-up footplate			
8350 9921 0001	[]	<i>Rubber plated footplate</i>			
	[]	Footrest, adjustable in height	Chose:-3,0 /-1,5 / 0 /+1,5 / +3,0 cm	_____ cm	(-) up (+) down , e.g.: -1,5 / +3,0
	[]	Footrest, fixed by welding			
	!	FRA: Angle of the footrest - measured in cm, topside back to front	_____ cm		
	!	FRD: Depth of the footrest	_____ cm		
8299 9901 2001	[]	Height of the adjustable footplate's bend	_____ cm		
	[]	FRP: Optional footplate pronounce, (std. 1, 3, 5 cm)	_____ cm	 Part of FRD	
6910 0001 0001	[]	RH: Welded rings for leg strap. Height from floor including strap	_____ cm	 Std 23 cm	
7660 0000 1011	[]	Heel straps for flip-up footrests		W5D and Dalton	

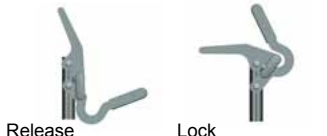



! Upholstery (mandatory)					
7100 ???? 1009	[]	Extra wide back upholstery for a deeper shape of the back	Chose between +1/+2/+3cm	_____ cm	
Important!		Adjustable depth of the seat upholstery (SD). SD can be made up to 10 cm longer than shortest possible position (SD-min).			
7200 ???? 1009	[!]	SD: Requested seat length (default between 39 and 44 cm)		_____ cm	
7100 9999 001?	[]	Leather back upholstery (detachable part)	<input type="checkbox"/> Black <input type="checkbox"/> Red <input type="checkbox"/> White <input type="checkbox"/> Blue <input type="checkbox"/> [] <input type="checkbox"/> [] <input type="checkbox"/> [] <input type="checkbox"/> []	Choose color	
7100 9999 000?	[]	Leather on the upper corners of the back upholstery (default: Black)	<input type="checkbox"/> Black <input type="checkbox"/> Red <input type="checkbox"/> White <input type="checkbox"/> Blue <input type="checkbox"/> [std] <input type="checkbox"/> [] <input type="checkbox"/> [] <input type="checkbox"/> []	Choose color	
7100 9999 100?	[]	Wolturnus logo on back	<input type="checkbox"/> Green <input type="checkbox"/> Red <input type="checkbox"/> Blue <input type="checkbox"/> White		
7610 0000 0010	[]	Pocket on back upholstery - bottom	<input type="checkbox"/> Small <input type="checkbox"/> Large		

Pushhandles					[] NO / NEJ
8852 0002 1001	[]	PH: Pushhandles, quick-release, height over backrest tube (default)		_____ cm	
8852 0004 1001	[]	Tetra pushhandles	<input type="checkbox"/> Fixed by screws <input type="checkbox"/> Welded		
8852 000? 1001	[]	Adjustable pushhandles	<input type="checkbox"/> Dia. Ø22 mm (only for pushing the wheelchair) <input type="checkbox"/> Dia. Ø25 mm (for lifting)		
		! Height from floor to anticipated utility position		_____ cm	
8852 0005 1002	[]	Foldable pushhandles, fixed with screws (extra tubes welded on the back)			
8852 0005 1005	[]	Foldable pushhandles, mounted in top of back tube (hence the upholstery lacks padding on its top)			
8852 0003 10??	[]	Pushbar - Fixed angle	<input type="checkbox"/> Straight <input type="checkbox"/> Curved (drawing)		
8852 0003 10??	[]	Pushbar - adjustable by angle	<input type="checkbox"/> Straight (drawing) <input type="checkbox"/> Curved		







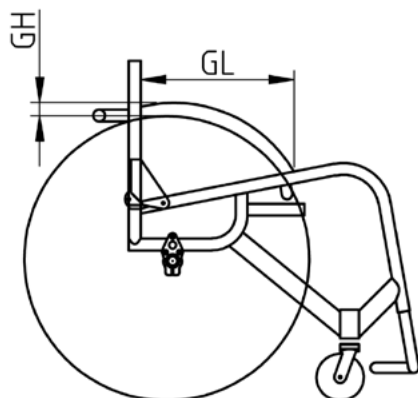

Wheel-locks (recommended choice) / Bremser (anbefalet valg)						
8851 1010 1001	<input type="checkbox"/>	Push-action wheel-locks				
8851 1010 1003	<input type="checkbox"/>	Push-action wheel-locks, bended handles (vertical)				
8851 1010 1101	<input type="checkbox"/>	Push-action wheel-locks (plastic fibre)				
8851 1020 1009	<input type="checkbox"/>	Scissor wheel-locks				
8851 1020 1109	<input type="checkbox"/>	Scissor wheel-locks small (plastic fibre)				
8851 1030 1009	<input type="checkbox"/>	Single stop wheel-lock	! <input type="checkbox"/> Handle, left	<input type="checkbox"/> Handle, right	18", 20" and 22" wheels only	
8851 2010 1009	<input type="checkbox"/>	One-hand activated wheel-lock	! <input type="checkbox"/> Handle, left	<input type="checkbox"/> Handle, right	Needs extra space!	
8851 1011 1001	<input type="checkbox"/>	Pull-activated wheel-lock				
8851 1011 1101	<input type="checkbox"/>	Pull-activated wheel-lock (plastic fibre)				
8851 1012 2002	<input type="checkbox"/>	Extensions for handles on the wheel-locks (for brakes with straight handles only)				
8537 2811 10??	<input type="checkbox"/>	Drum brakes with lockable grips with activation cables				





Anti-tip (recommended choice)					[] NO / NEJ	
8861 1010 1300	<input type="checkbox"/>	Swing away anti-tip - Right				
8861 1010 1300	<input type="checkbox"/>	Swing away anti-tip - Left				
8861 1010 ??01	<input type="checkbox"/>	Centermounted anti-tip				(Welded tube, rear)
	!	AF: Height from floor	_____ cm	AW: Distance to axle	_____ cm	

Sideguards and Armrests / Sidestykker og armlæn

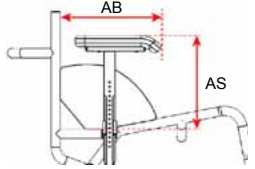
8810 2410 1001	<input type="checkbox"/>	Dibond sideguards (default option)				
8810 2410 2001	<input type="checkbox"/>	Dibond sideguards (tailor-made)			Dibond sideguard	
8812 2401 0009	<input type="checkbox"/>	Carbon sideguards with mudguard Note: Fixed curve				
8812 2401 1009	<input type="checkbox"/>	Carbon sideguards without mudguard (tailor-made)			Carbon sideguard with mudguard	
8812 2402 0009	<input type="checkbox"/>	Welded-on aluminum sideguards				
8812 2402 0020	<input type="checkbox"/>	Welded-on aluminum sideguards with mudguard			Alu sideguard welded on	
8812 2403 0009	<input type="checkbox"/>	Aluminum sideguards 2 mm, fixed with screws				
8812 2403 0010	<input type="checkbox"/>	Aluminum sideguard with mudguard, fixed with screws			Alu sideguard fixed with screws	
These options are defined in advance by default	!	GH: Height from tires to the upper edge of the sideguards		_____ cm	If GL is not defined, the sideguards will follow the wheels by distance GH	
<i>Ved standardvalg er disse valgt på forhånd.</i>	!	GL: Length from the back tubes to the front of the sideguards		_____ cm	See drawing below	
	!	Mudguards, coverage (default, to the middle of the tire)		_____ cm	From inside to outer edge	
7670 0000 00??	<input type="checkbox"/>	Thermal protection for sideguards (default)	<input type="checkbox"/>	Left/	<input type="checkbox"/>	3 mm (std)
			<input type="checkbox"/>	Right/	<input type="checkbox"/>	10 mm
					<input type="checkbox"/>	20 mm
8831 2410 1008	<input type="checkbox"/>	Nylon side guards, including inside aluminum rails/bands				
8831 2410 1001	<input type="checkbox"/>	Armrest with ABS sideguards			Choose armrest pads on the next page	
8831 2410 1004	<input type="checkbox"/>	Reinforced armrest with ABS sideguards				

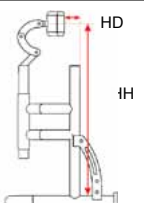

9510 0008 0126	<input type="checkbox"/>	23,5 cm armrest pad, displaced by 2 cm		
9510 0008 0122	<input type="checkbox"/>	27 cm armrest pad, displaced 2 cm		
9510 0008 0125	<input type="checkbox"/>	37 cm armrest pad, long, displaced 2 cm		
9510 0008 0127	<input type="checkbox"/>	26 cm leather armrest pad, width 8 cm		
9510 0008 0128	<input type="checkbox"/>	31 cm armrest pad, leather, width 8 cm		
9510 0008 0119	<input type="checkbox"/>	16 cm armrest pad, short		
9510 0008 0220	<input type="checkbox"/>	23,5 cm armrest pad, short (default)		
9510 0008 0121	<input type="checkbox"/>	27,5 cm armrest pad		
	!	AS: Height from the seat tube to the top of the armrest	_____ cm	
	!	AB: Length from the front of the backrest to the front of the armrest	_____ cm	

Headsupport				<input type="checkbox"/> NO	
8841 0001 4001	<input type="checkbox"/>	Headsupport, adjustable - choose cushion below	HH: _____ cm	HD: _____ cm	
		9510 0008 0130 <input type="checkbox"/> Small rounded (23 x 10 x 4 cm)			
		9510 0008 0131 <input type="checkbox"/> Large rounded (30 x 14 x 4 cm)			
	!	8841 0000 100 <input type="checkbox"/> Small square			
		8841 0000 1020 <input type="checkbox"/> Large square			
		8400 0010 0012 <input type="checkbox"/> Gel headrest, small (19 x 15 x 5 cm)			
		8400 0010 0011 <input type="checkbox"/> Gel headrest, large (28 x 19 x 7,6 cm)			
8841 1000 1010	<input type="checkbox"/>	Attachment for strap fixation (to protect the neck, when using body straps)			

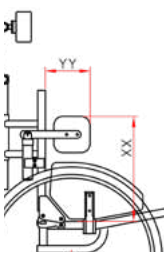
Bodysupport (drawings on page 16)						
8840 1010 0001	<input type="checkbox"/>	Bodysupport, adjustable, right side - choose cushion below		XX: _____ cm	YY: _____ cm	
8840 1010 1002	<input type="checkbox"/>	Bodysupport, adjustable, left side - choose cushion below		XX: _____ cm	YY: _____ cm	
	!	8840 1010 1010 <input type="checkbox"/> Small 6 x 10 cm	8840 1010 1011 <input type="checkbox"/> Medium 8 x 12 cm			
		8840 1010 1012 <input type="checkbox"/> Large 12 x 12 cm	8840 1010 1075 <input type="checkbox"/> Custom ___X___cm			

Car fixation			[] NO
8870 0020 0001	[]	4-point fittings for strap fastening	
887000200011	[]	Fittings for Dahl Docking Station <i>Beslag til Dahl Docking Station</i>	

Accessories / Tilbehør						[] NO		
6910 0002 0020	[]	Tip assistant pedal	[]	Right	[]	Left		
8862 1010 1001	[]	Double crutch holder (2 x Ø47 mm)	[]	Right	[]	Left		
8831 2410 1002	[]	Swing-away armrest, attached behind the back tubes (See page 4, section 1)					Go to p. 4, section 1	
	[]	Seat-armrest top	_____cm	Length from back:	_____cm			
88520 0100 1001	[]	Caster pin locks (activated by cables)						
8537 2811 1009	[]	One-hand propelling (22" and 24" spoke wheels)						
9530 0114 0120	[]	Quick-release axle with Tetra grip						
8624 0000 1009	[]	Front forks with quick-release axle (detachable)						
8513 0600 1009	[]	Transit wheel for entering through narrow doorways						
	[]	Extra wheel(s) as req., see next page	[]	1 Pair	[]	1 pcs.		
7600 0001 00??	[]	Frame protectors	[]	Front tubes	[]	Backrest tubes		
7610 0000 00??	[]	Bag for catheter etc. (can be fixed under the seat)			[]	Small	[] Large	
6910 0001 0113	[]	Mounting for Batec auxiliary motor or hand bike						

Fill in and send to 49 Bespoke Inc.

Subject to Technical Modifications and Printing Errors

© Wolturnus AS OF W5 EN-DA 2016 v5.4

Front Wheels (Casters)		[] NO
8600 1020 0801	Front wheel Skater 80 mm	[]
8600 1020 1001	Front wheel Skater, 100 mm	[]
8632 0100 2009	Front wheel skater w. light 100 mm	[]
8631 0125 1001	Front wheel Skater, 125 mm	[]
8600 1010 1001	4" Front wheel grey, 26 mm width	[]
8600 1010 1002	4" Front wheel grey, 32 mm width	[]
8600 1010 1251	5" Front wheel grey, 29 mm width	[]
8600 1010 1253	5" Front wheel grey 40 mm width	[]
8600 1010 1401	Front wheel grey, Ø140 mm	[]
8600 1010 200?	4" Fiber plast front wheel 34 mm width	[]
8600 1010 2015	5" Fiber plast front wheel 34 mm width (Only in black)	[]
Colour on front wheel rim - Fiber wheel only		
	<input type="checkbox"/> Black <input type="checkbox"/> Blue <input type="checkbox"/> Red <input type="checkbox"/> white <input type="checkbox"/> Silver	
8600 1020 1051	4" Alu front wheel 35 mm width	[]
8600 1020 1252	5" Alu front wheel 35 mm width	[]
Colour on front wheel rim		
9664 0100 0720	<input type="checkbox"/> Black <input type="checkbox"/> Silver <input type="checkbox"/> Green <input type="checkbox"/> Red <input type="checkbox"/> Orange	
	<input type="checkbox"/> Blue <input type="checkbox"/> Purple <input type="checkbox"/> Yellow <input type="checkbox"/> Pink	
Colour Front Wheel Fork		
8999 9999 0004	<input type="checkbox"/> Black	
8999 9999 0005	<input type="checkbox"/> Nature / silver	
8999 9999 0006	<input type="checkbox"/> Red	
8999 9999 0007	<input type="checkbox"/> Blue	

Rear Wheels / Drivhjul		[] NO / NEJ			
		22"	24"	25"	26"
8510 2?10 1009	Spoke wheels (<i>standard</i>)	[]	[]	-	[]
8510 2510 1009	Spoke wheels (<i>standard</i>)	-	-	[]	-
8532 2410 1009	Decon Spider Black	-	[]	-	-
8532 2411 1009	Decon Spider Silver	-	[]	-	-
8535 2?10 1?08	Spinergy 12 spokes LX	-	[]	[]	-
8535 2?10 1?09	Spinergy 18 spokes L	-	[]	[]	-
Colour Spinergy spokes					
	<input type="checkbox"/> Std. Black <input type="checkbox"/> Blue <input type="checkbox"/> White <input type="checkbox"/> Red <input type="checkbox"/> Orange <input type="checkbox"/> Yellow <input type="checkbox"/> Pink <input type="checkbox"/> Green				
8537 292? 2401	Upgrade Wrex Light 24 crossed spokes	-	[]	[]	-
8537 292? 3601	Upgrade Wrex Light 36 radial spokes	-	[]	[]	-

Pushrims / Drivringe		[] NO			
		22"	24"	25"	26"
Mounting <i>Montering</i>	<input type="checkbox"/> Short <input type="checkbox"/> Long				
8551 ??10 2009	Alu pushrims (default)	[]	[]	[]	[]
8555 ??00 0009	Titan pushrims Ø 19	[]	[]	[]	[]
8554 ???? 0009	High friction pushrims	-	[]	[]	[]
8552 2401 0001	Decon Alu pushrims	-	[]	-	-
8552 2401 0002	Decon Titan pushrims	-	[]	-	-
8552 2401 0003	Decon Dual grip / S-friction	-	[]	-	-
8553 ??01 0009	Dual grip / S-friction	[]	-	[]	-
8553 2406 0009	Surge LT oval 6L	-	[]	[]	-
8561 2410 0001	Plastic pushrims	[]	[]	-	[]
8550 2?10 3009	Steel pushrims	[]	[]	[]	[]
8554 ???? 0009	Maxgrepp Ergo Para cp	[]	[]	-	-
8554 ???? 0008	Maxgrepp Original pushrim Ø25 mm (Mossrubber)	[]	[]	[]	-
8554 ???? 0009	Maxgrepp Original pushrim Ø32 mm (Mossrubber)	-	[]	-	-
8554 ??08 0009	Curve L TG (friction)	-	[]	[]	-
8557 ??03 0001	B-Braver, short mounting	[] Orange	[] Black	[] White	[]*
8557 ??03 0002	B-Braver, long mounting	[] Orange	[] Black	[] White	[]*
		* Only black			

Tyres		[] NO			
		22"	24"	25"	26"
9662 0000 00??	Standard tires, grey 1"	[]	[]	[]	[]
9662 ??01 000?	Schwalbe Marathon, black, 1"	[]	[]	[]	[]
9662 ??01 00??	Schwalbe Marathon, grey, 1"	-	[]	[]	-
9662 2401 0009	Solid tire, grey, 1"	-	[]	-	-
9662 2401 0011	Schwalbe Right Run, blue, 1"	[]	[]	-	-
9662 2401 0012	Schwalbe Right Run, red, 1"	[]	[]	-	-
9662 2401 0007	Schwalbe Marathon, grey, 1-3/8"	-	[]	-	-

Tires		[] NO			
		22"	24"	25"	26"
9662 2402 0001	Table Top 57-507 (outer measures same as 25")	-	-	[]	-
9662 2402 0004	Landcruiser 24" 50-507" (outer measures same as 24")	-	[]	-	-

Spoke Guards		22"	24"	25"	26"
8571 ??10 2117	Girl	[]	[]	-	-
8571 ??10 2109	Bat	[]	[]	-	-
8571 ??10 2115	Dolphin	[]	[]	-	-
8571 ??10 2116	Globe	[]	[]	-	-
8571 ??10 2111	Dragon	[]	[]	-	-
8571 ??10 2114	Horses	[]	[]	-	-
8571 ??10 2110	Lightning	[]	[]	-	-
8571 ??10 2112	Lion	[]	[]	-	-
8571 ??10 2113	Shark	[]	[]	-	-
8571 ??10 2118	Spider	[]	[]	-	-
8571 ??10 2009	TRANSPARENT	[]	[]	[]	[]

Custom-made

Description

Drawing

